

Goods covered under 5 year limited warranty offered by Euro-Rite Cabinets Ltd. For full warranty information, please visit [www.eurorite.com](http://www.eurorite.com) -support-warranty.

Les marchandises couvertes au-dessous de 5 ans ont limité la garantie offerte par Euro-Rite Cabinets Ltd. Pour des informations complètes de garantie, visitez svp [www.eurorite.com](http://www.eurorite.com) - appui - garantie

Las mercancías cubiertas bajo 5 años limitaron la garantía ofrecida por Euro-Rite Cabinets Ltd. Para la información completa de la garantía, visite por favor [www.eurorite.com](http://www.eurorite.com) - ayuda - garantía

## Assembly Instructions

### Instructions D'Assemblée Instrucciones de asamblea

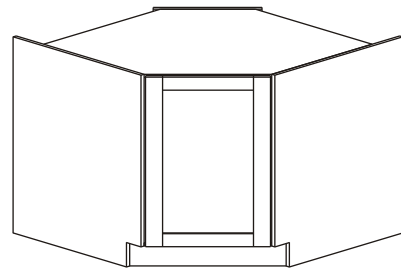

#### Corner Diagonal Base Cabinet

Cabinet Bas Diagonal Faisant le coin  
Gabinete Bajo Diagonal De la esquina



1

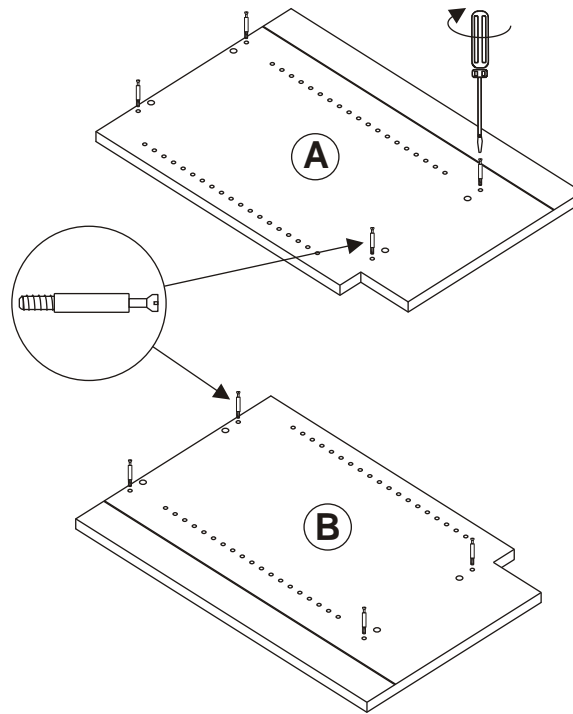

2

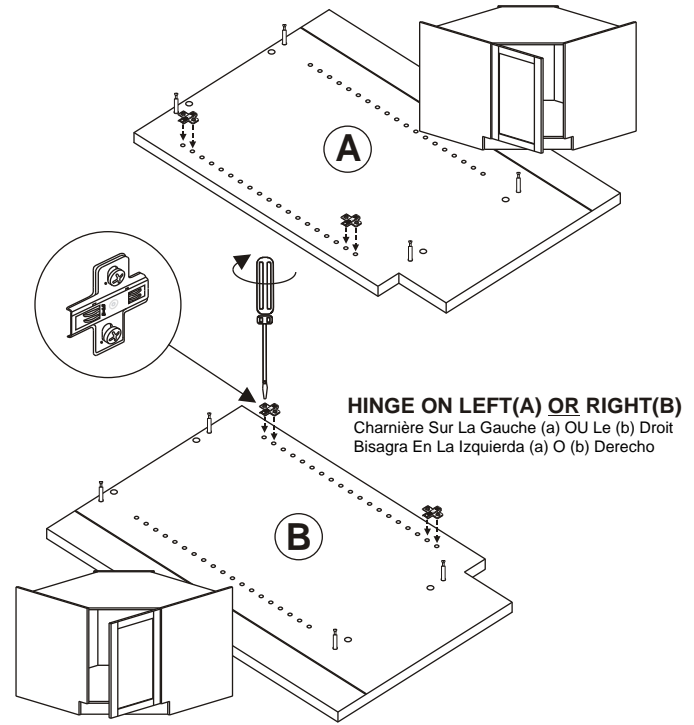
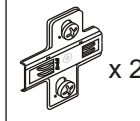

BOX  
Boîte  
Caja  
**A**

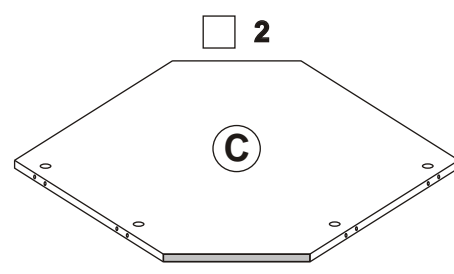
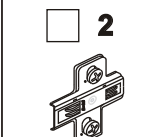
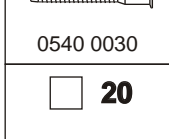
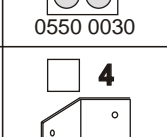
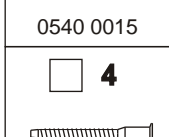
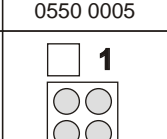
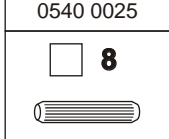
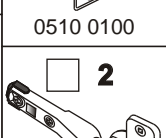
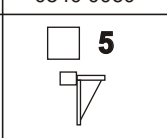
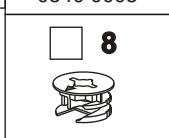
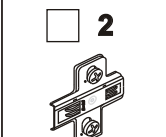
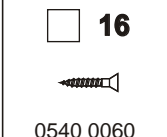
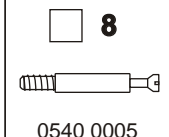

**ASSEMBLY SHELF**  
Étagère d'Assemblée  
Estante de la asamblea

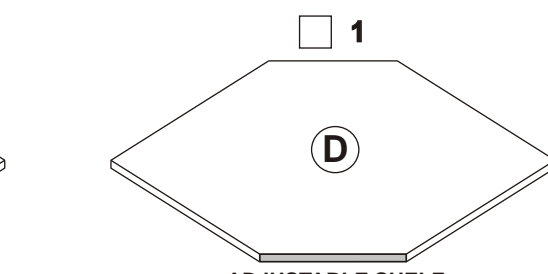

**ADJUSTABLE SHELF**  
Étagère réglable  
Estante ajustable

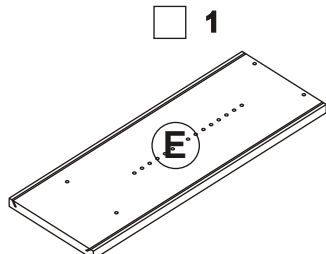

**BACK LEG**  
Jambe Arrière  
Pierna Trasera

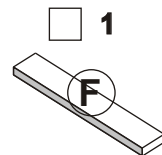

**VALANCE**  
Valance  
Valance

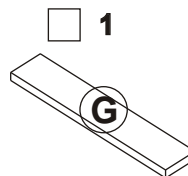

**TOE KICK**  
Coup-de-pied D'Orteil  
Retroceso Del Dedo del pie

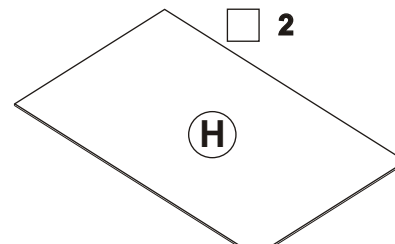

**BACKBOARD**  
Panneau arrière  
Tablero trasero

BOX  
Boîte  
Caja  
**B**

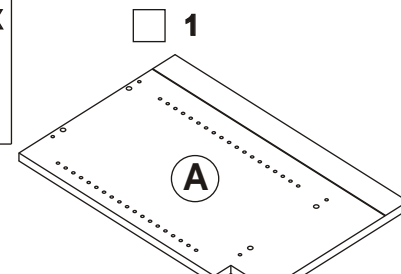

**LEFT HAND GABLE (SIDE PANEL)**  
Pignon de main gauche (panneau latéral)  
Aguilón de la mano izquierda (panel lateral)

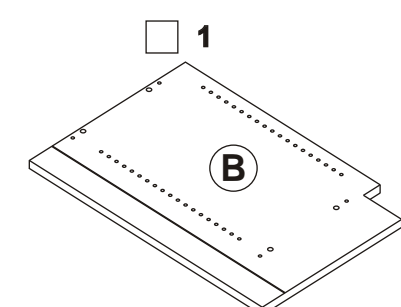

**RIGHT HAND GABLE (SIDE PANEL)**  
Pignon droit (panneau latéral)  
Aguilón derecho (panel lateral)

BOX  
Boîte  
Caja  
**C**

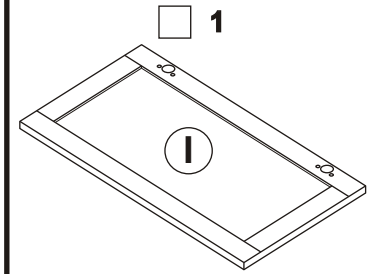

**DOOR PANEL**  
Panneau de porte  
Panel de la puerta

3

 x 8

 x 8

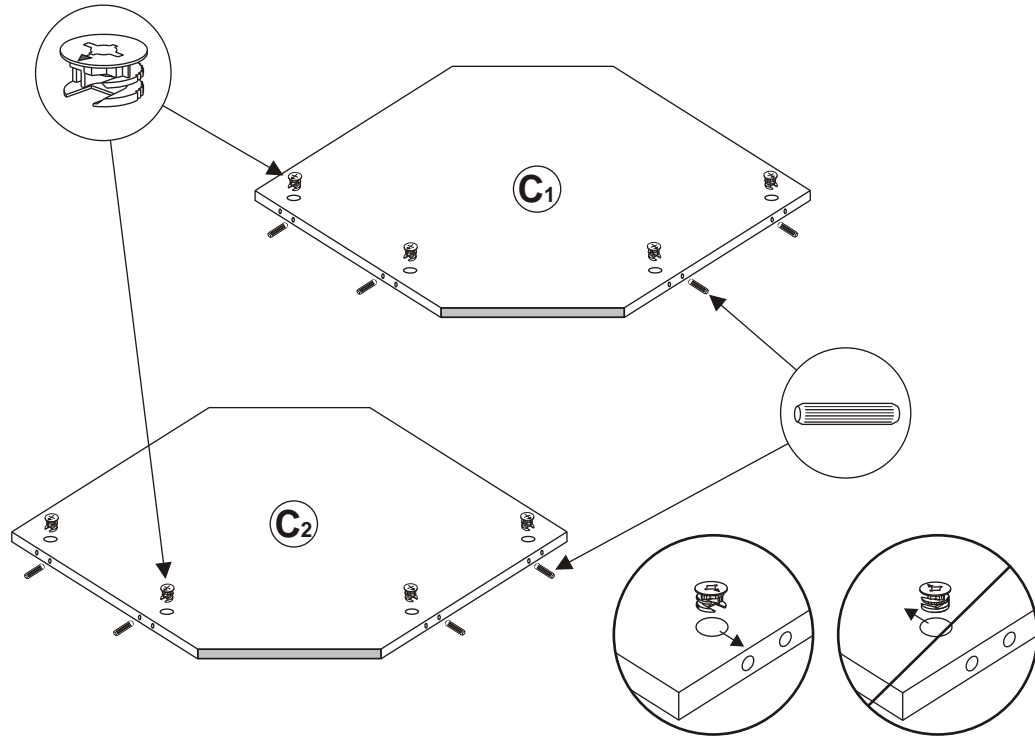

4

C1&2 → B

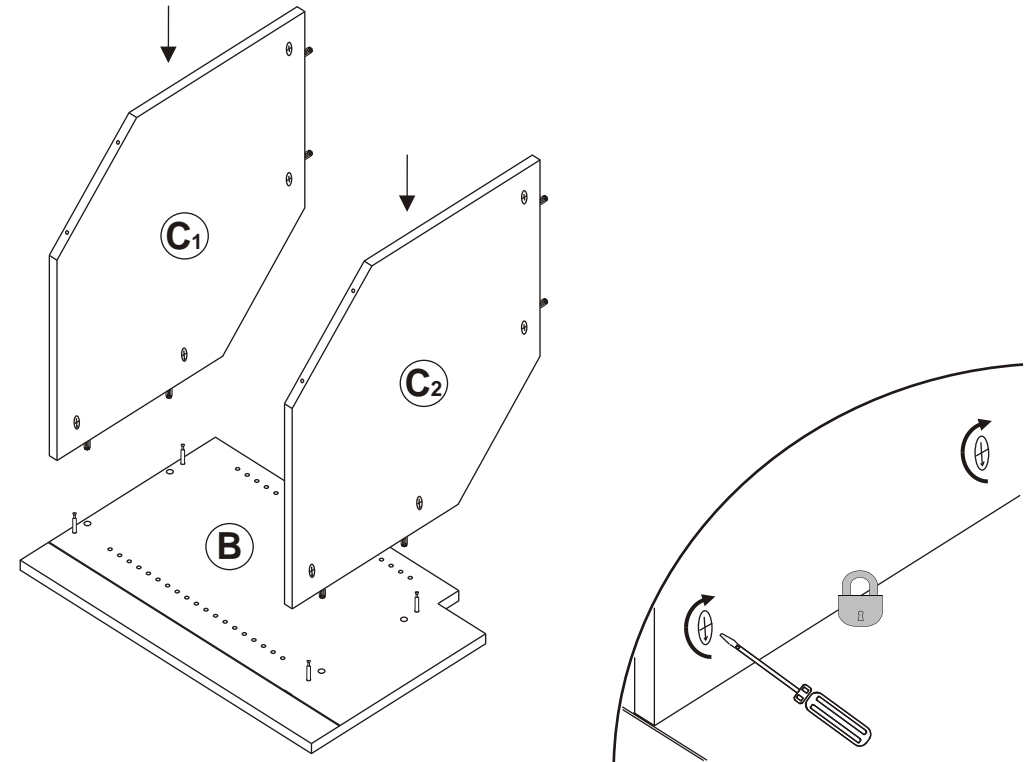

5

 x 4

E → C1&2

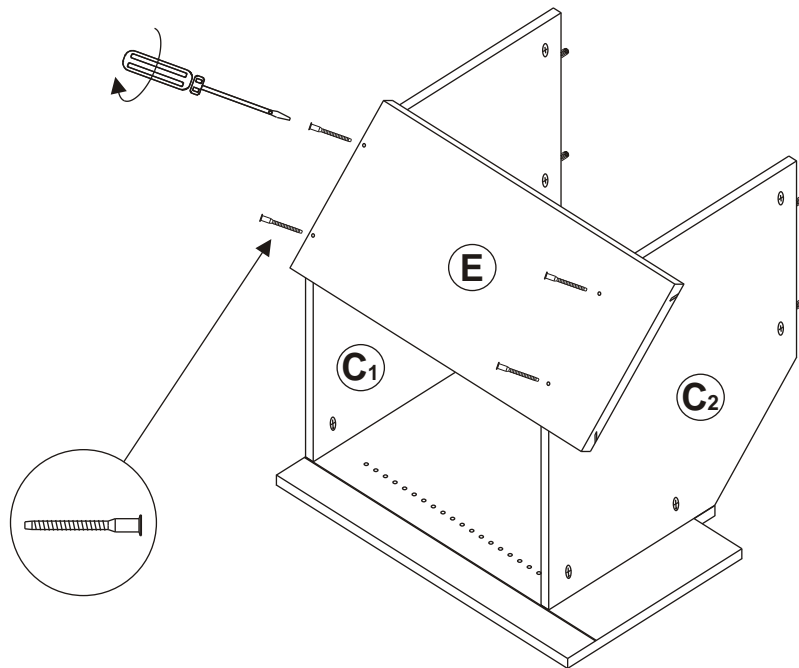

6

A → C1&2

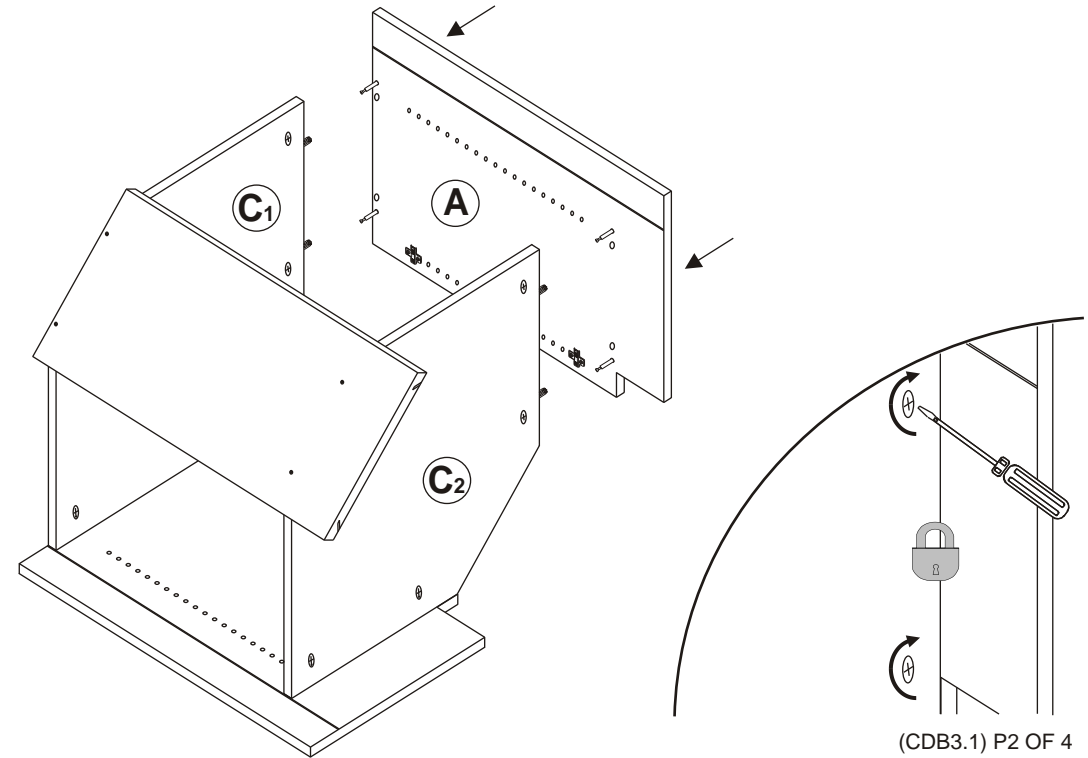

7

x 20

H1 → E,B  
H2 → E,A

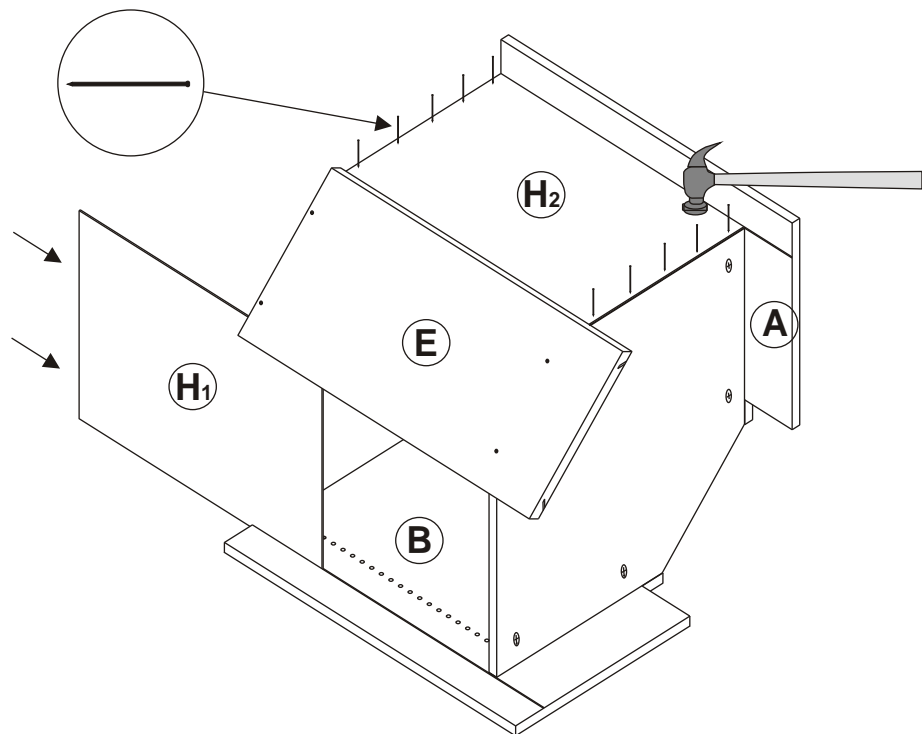

8

x 2

x 8

G → A,B

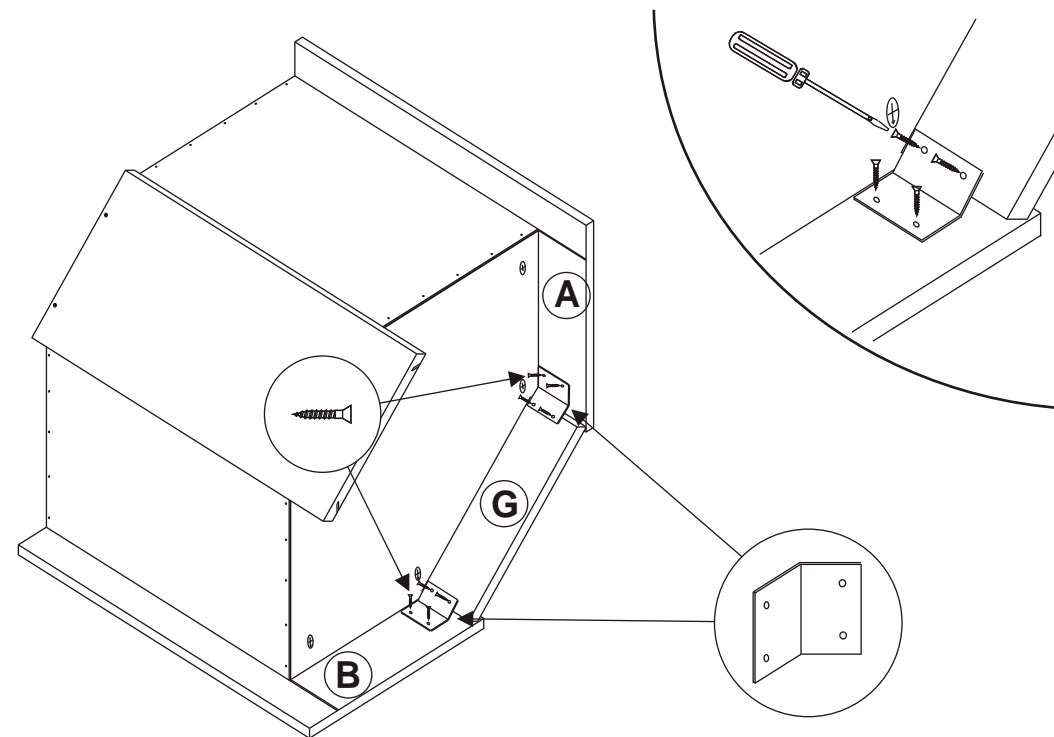

9

x 5

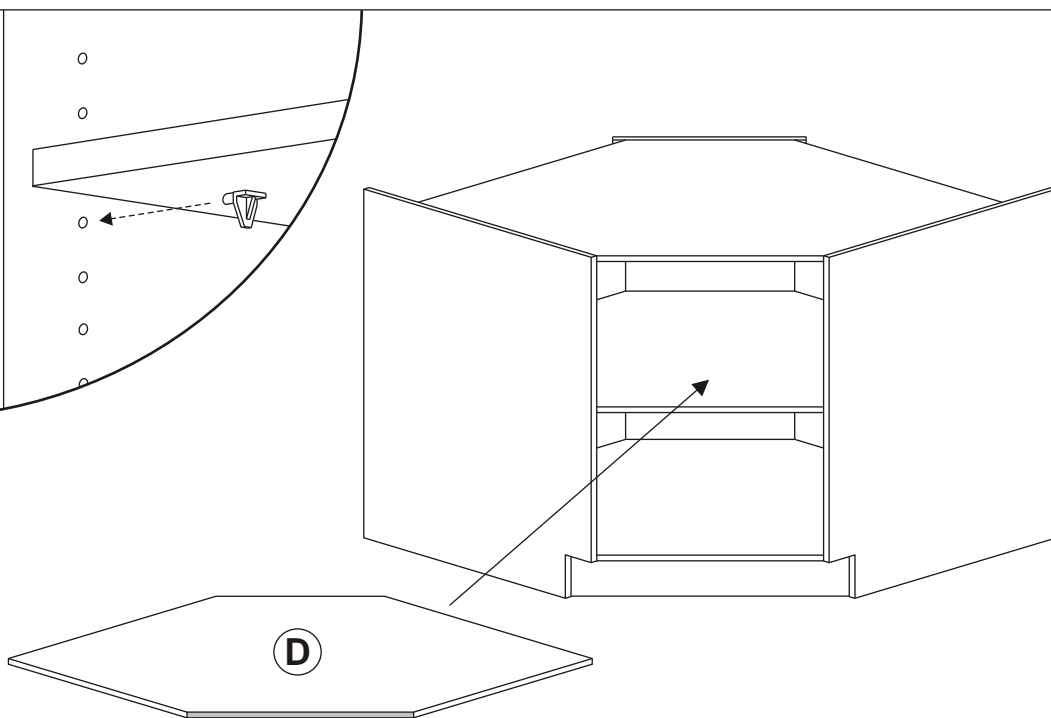

10

x 2

x 8

F → A,B

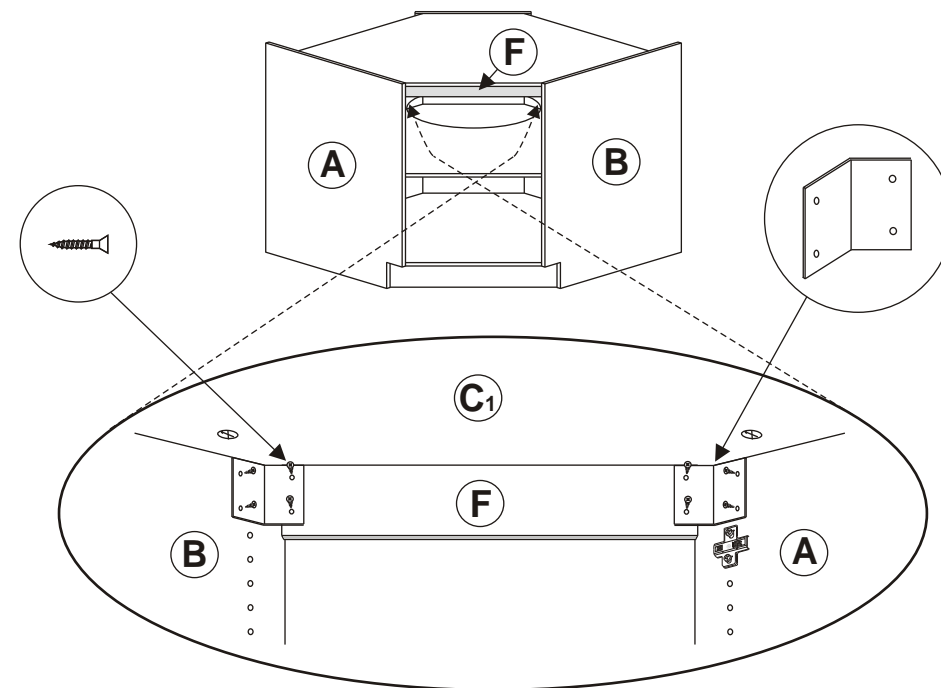

11

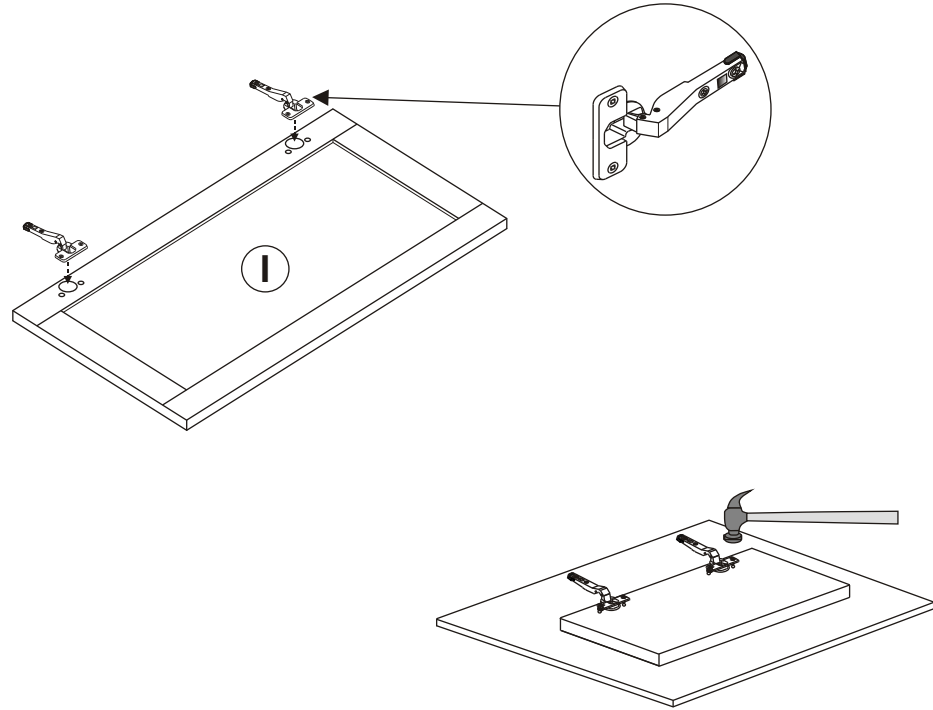
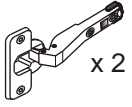

12

